

# Electrochemistry

Chemistry

12

## 12.1 Electrochemical cells

In our everyday life, we frequently use equipment powered by domestic electricity as well as appliances operated by electrochemical cells or batteries. Toy cars, electric torches, calculators, computers and mobile phones are a few examples for equipment that are powered by electrochemical cells.



A toy car powered by batteries



An electric torch



A mobile phone



A calculator



A computer

**Figure 12.1.1 - Equipment powered by electrochemical cells**

The electrochemical cells or batteries used in the examples given above are small in size. A battery used to start a car is large in size. Such a battery is a collection of several electrochemical cells.



**Figure 12.1.2 - Different types of cells and batteries**

In your former grades you have learnt about electrochemical cells. In those cells, the chemical energy stored in the chemicals they contain is converted to electrical energy. In this section, we study further the reactions occurring in electrochemical cells and the action of those cells.

For this, let us do the activity 12.1.1 described below.

### Activity 12.1.1

**Materials required** :- A small beaker, dilute sulphuric acid, a zinc metal sheet

**Method** :-

- Add dilute sulphuric acid to the small beaker. Place a strip of zinc metal sheet in the beaker so that a part of it dips in the sulphuric acid solution as shown in the figure 12.1.3 Record your observations.

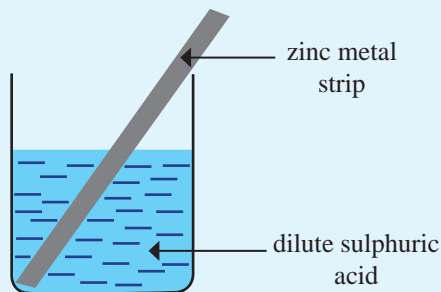
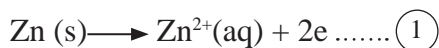

Figure 12.1.3

Here, it can be observed that, gas bubbles are liberated near the zinc strip and the zinc strip dissolves gradually. Let us find the reasons for those observations.

Zinc atoms (Zn) go into the solution as zinc ions ( $\text{Zn}^{2+}$ ) leaving electrons on the metal. Electrons get accumulated on the zinc strip. This process can be shown as follows using chemical symbols.



Sulphuric acid dissociates into hydrogen ions ( $\text{H}^+$ ) and sulphate ions ( $\text{SO}_4^{2-}$ ) in water. This can be illustrated as follows.



The  $\text{H}^+$  ions in the solution are attracted towards the zinc strip to capture the electrons on it. Hydrogen ions, after receiving the electrons become hydrogen gas ( $\text{H}_2$ ). Using chemical symbols, this can be written as follows.



The reactions written as  $\textcircled{1}$  and  $\textcircled{2}$  above, depicting the conversion of one chemical species into another, either by removing or accepting electrons, are called 'half reactions'. By adding two half reactions appropriately, the balanced ionic equation can be obtained.

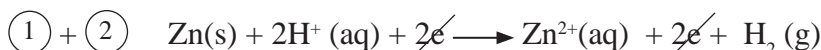
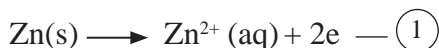

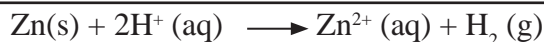

Next, let us consider how this reaction can be represented by a balanced chemical equation. The hydrogen ions ( $\text{H}^+$ ) were added to the solution by the dissociation of sulphuric acid ( $\text{H}_2\text{SO}_4$ ). When sulphuric acid dissociates sulphate ions ( $\text{SO}_4^{2-}$ ) are also added to the medium in addition to  $\text{H}^+$  ions. But sulphate ions do not undergo any change during the reaction. So, we add  $\text{SO}_4^{2-}$  to both sides.

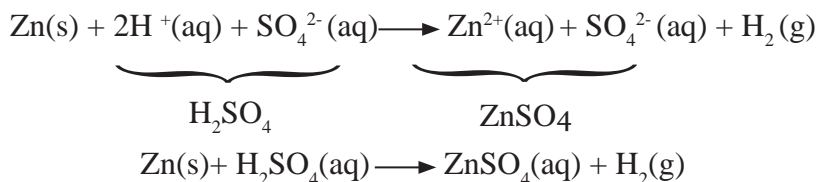

Given above is the complete reaction for which zinc metal reacts with dilute sulphuric acid. If the exchange of electrons taking place between the zinc metal and  $\text{H}^+$  ions during the above process occurs through an external conductor, we can produce an electric current.

Let us do the following activity to see whether this can be done.

### Activity 12.1.2

**Materials required** :- A beaker, zinc and copper strips, dilute sulphuric acid, connecting wire, Ammeter.

**Method** :- • Connect the zinc strip and the copper strip to the Ammeter using connecting wires as shown in the Figure 12.1.4. Then immerse the two metal strips in the beaker containing dilute sulphuric acid. Record your observations.

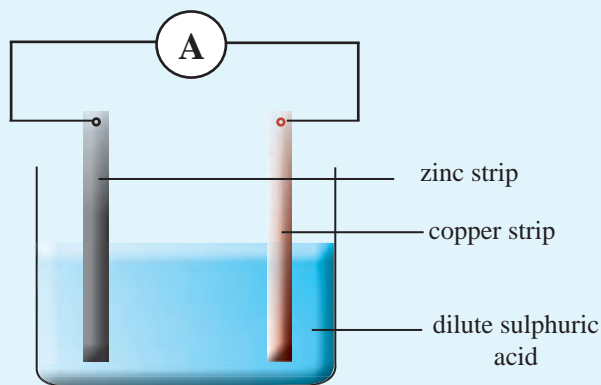

Figure 12.1.4

In this, it can be observed that the Ammeter pointer is deflected, zinc strip is dissolved and gas bubbles are evolved at the copper strip.

Let us explore the reasons for these observations.

Here too, zinc atoms become zinc ions ( $\text{Zn}^{2+}$ ) leaving electrons on the metal. Therefore, the zinc strip dissolves.

The electrons accumulated on the zinc strip, flow towards the copper strip through an external wire. This flow of electrons is considered an electric current. Deflection of the Ammeter shows that an electric current flows through the circuit. Hence in this set up,  $H^+$  ions in the solution move toward the copper strip and receive electrons from it. Therefore, hydrogen gas bubbles are liberated at the copper strip.

Reaction at the zinc strip

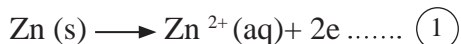

Reaction at the copper strip



In the above reaction it was confirmed that an electron current flows from zinc to copper in the external wire. A current of electrons means an electric current. In this, a chemical reaction has generated an electric current. A set up of this kind used to generate electricity by a chemical reaction is known as an electrochemical cell. The conducting substances dipped in the electrolyte here are called electrodes.

In the above cell, zinc strip and copper strip act as electrodes. The balanced ionic equation obtained by adding the half reactions (1) and (2) above is the electrochemical reaction taking place in the cell.

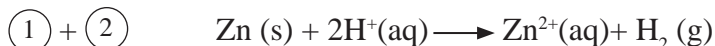

Let us further consider the reaction occurring at the zinc electrode in the above cell.

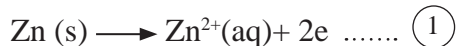

Loss of electrons from a given species (atoms, molecules or ions) is referred to as oxidation. Therefore, what is happening at the zinc strip is **oxidation**. If oxidation occurs at a certain electrode, that electrode is defined as the **anode**. Accordingly, the zinc strip is the anode of the above cell. Equation (1) represents the **oxidation half reaction** taking place at the anode. Since zinc atoms dissolve into the solution leaving electrons on the zinc plate, the zinc plate gets negatively charged relative to the copper plate. Therefore, zinc electrode is the **negative terminal** of the cell.

Next let us consider the reaction occurring at the copper strip.



The hydrogen ions ( $H^+$ ) gaining electrons turn into hydrogen gas molecules ( $H_2$ ). Gaining electrons by a given species (atoms, molecules, ions) is described as a **reduction**. Since gaining of electrons or a reduction occurs at the copper electrode, reaction (2) is the **reduction half reaction**.

If reduction occurs at a certain electrode, it is defined as the **cathode**. Therefore, copper strip is the cathode of the cell. Since electrons flow to the copper strip, it is positively charged relative to the zinc strip. Therefore, copper electrode is the positive terminal of the cell.

The electrochemical reaction of the cell can be obtained by adding the reactions (1) and (2).

At the zinc electrode/negative terminal:

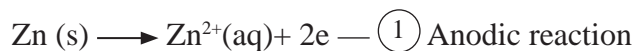

At the copper electrode/positive terminal:

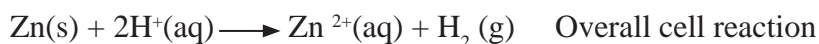
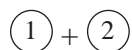
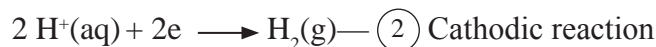

The following comparisons would be important for you to identify the anode and cathode of a given electrochemical cell.

- The metal placed higher in the activity series acts as the anode and the metal placed lower in the activity series acts as the cathode.
- Oxidation occurs at the anode and reduction occurs at the cathode.
- Anode becomes the negative terminal of the cell while cathode becomes the positive terminal of the cell.

### Note

In a cell, electrons flow from the negative terminal to the positive terminal. But, according to the conventions in physics, the conventional current is marked as flowing from the positive terminal to the negative terminal.

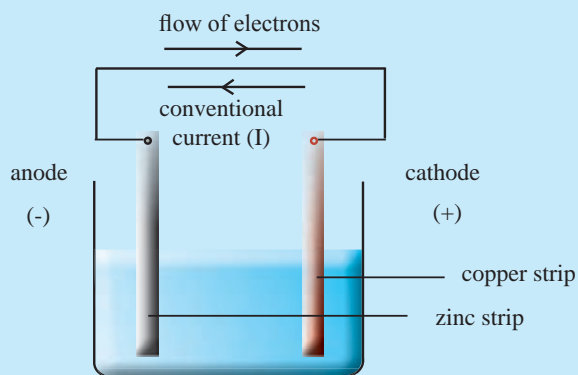

Figure 12.1.5

Next, let us consider a cell constructed using iron and copper electrodes.

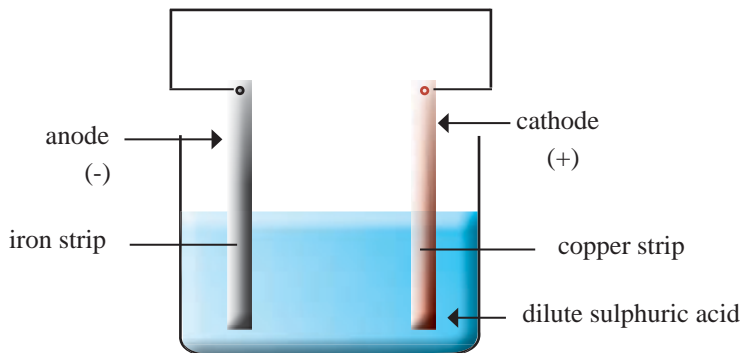
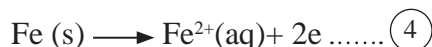

Figure 12.1.6

In the activity series, iron lies above copper. Therefore, what is subjected to **oxidation** and acts as the **anode** is the more reactive metal, iron.



Since iron atoms dissolve into the solution leaving electrons on the iron strip, it is negatively charged relative to copper. Thus, iron electrode is the **negative terminal** of the cell.

In this cell also, the following reduction half reaction occurs at the less reactive copper metal. Therefore, copper electrode acts as the cathode of this cell.



Electrons flow to the copper electrode across the external wire. Therefore, copper electrode is the **positive terminal** of the cell.

The overall ionic reaction of the cell can be obtained by adding the two half reactions  $\textcircled{4}$  and  $\textcircled{5}$ .



When a current is drawn from this cell it can be observed that the iron electrode dissolves and gas bubbles evolve at the copper electrode.

Consider the following cell constructed using zinc and iron electrodes.

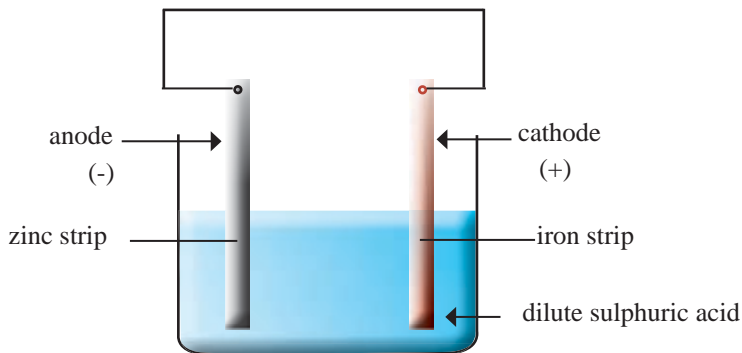
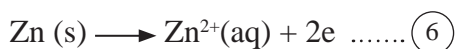

Figure 12.1.7

In the activity series, zinc metal is placed above iron. Therefore, zinc which is the more reactive metal, undergoes oxidation and acts as the anode.

Reaction at the zinc electrode/anode



Here too, as the zinc atoms dissolve into the solution leaving electrons on the zinc electrode, zinc becomes negatively charged relative to iron. For this reason, zinc electrode becomes the **negative terminal** of the cell.

Reaction at the iron electrode/cathode



Because reduction occurs at iron, it acts as the **cathode**.

Electrons flow towards the iron electrode along the connecting wire. Hence iron electrode is the **positive terminal** of the cell.

The overall ionic reaction of the cell can be obtained by adding the reactions  $\textcircled{6}$  and  $\textcircled{7}$ .



When this cell operates, we will be able to see that the zinc electrode dissolves and gas bubbles evolve at the iron electrode.

## 12.2 Electrolysis

You would have seen the goldsmiths burnishing gold/silver jewellery near the jewellery shops in town.

If you have not seen such a person, make it a point to observe well the equipment he has, when you meet such a person next time. You may be able to see a battery supplying electricity, wires connected to it and a vessel filled with a certain solution. He uses a narrow gold foil as one electrode and the piece of jewellery that needs to be polished as the other electrode. What he does with these equipment is the application of gold on the piece of jewellery.

Using the above process, he deposits gold on various jewellery. He lets an electric current to pass through the solution.

The chemical changes brought about by passing electricity through a solution/liquid which conduct electricity are called electrolytic processes. This chapter discusses about electrolysis. For this, let us first do the following activity to find out about the liquids/solutions which conduct electricity.

### Activity 12.2.1

#### Materials required :-

Carbon electrodes, two torch cells (1.5v), connecting wires, a ammeter, beakers, coconut oil, kerosene, distilled water, acidified water, salt solution, ethanol

#### Method :-

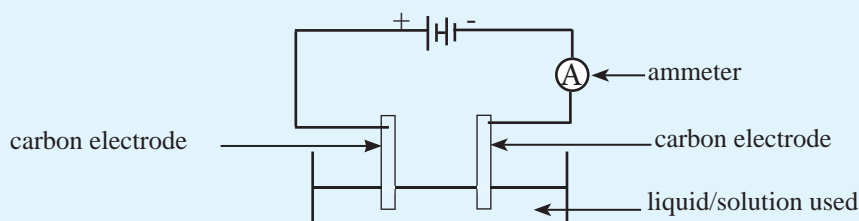

Figure 12.2.1

- Dip the carbon electrodes in the above liquids/solutions and see whether there is a deflection in the Ammeter.
- Record your observations.

A deflection in the ammeter could be observed only when acidified water and the salt solution are used in the above set up. That means, those solutions conduct electricity.



- The liquids/solutions conducting electricity are referred to as electrolytes. Some examples for electrolytes are given below.
  - » Aqueous solutions of ionic compounds  
e.g. aqueous sodium chloride, aqueous copper sulphate
  - » Molten (fused) liquids of ionic compounds  
e.g. fused sodium chloride
  - » Solutions of acids  
e.g. aqueous hydrochloric acid, aqueous sulphuric acid
  - » Solutions of bases  
e.g. aqueous sodium hydroxide
- The liquids/solutions that are not conducting electricity are non-electrolytes. Some examples for non-electrolytes are:
  - » Pure water (distilled water)
  - » Organic liquids  
e.g. petrol, kerosene, paraffin, hexane

**For your memory file**

The solid ionic crystals formed by the oppositely charged ions do not contain mobile ions. Therefore they cannot conduct electricity. But, when they are dissolved in water or fused (heated till the solid melts) its ions become mobile. For this reason, aqueous solutions or molten liquids of ionic compounds conduct electricity. The hydrocarbons such as petrol, kerosene and paraffin are compounds with covalent bonds, so they do not conduct electricity. Pure water is also covalent and there are almost no ions. Therefore, pure water does not conduct electricity. In aqueous solution, the covalent bonds in acids such as hydroiodic acid (HI), hydrochloric acid (HCl) and sulphuric acid ( $\text{H}_2\text{SO}_4$ ) break to form ions. Therefore the solutions of acids such as these conduct electricity.

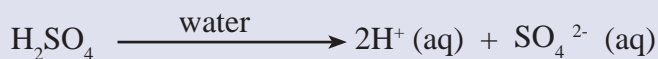
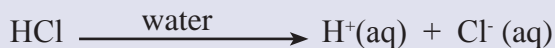

An apparatus set up to conduct electricity through an electrolyte is shown in the following figure. A set up such as this is called an electrolytic cell. An electrolytic cell comprises of a source of electricity, an electrolyte, two electrodes and connecting wires.

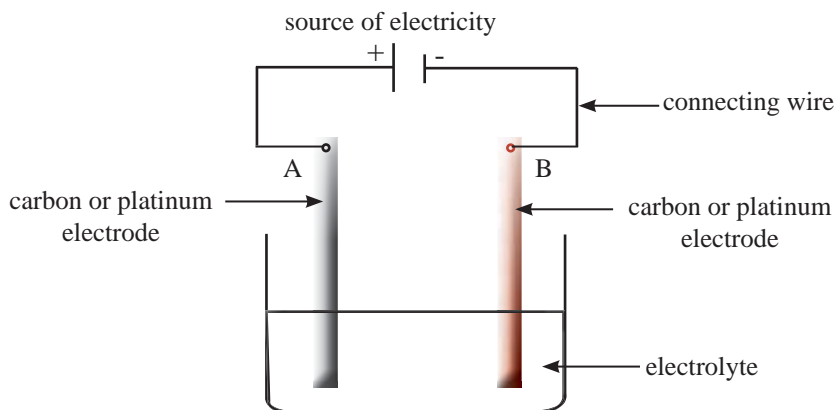

Figure 12.2.2 - An electrolytic cell.

Let us consider the supply of electricity to an electrolytic cell containing an aqueous solution of sodium chloride as the electrolyte. Liberation of gas bubbles can be seen at the carbon electrodes. This indicates that a chemical change has taken place in the aqueous solution.

Bringing about a generally non-spontaneous chemical reaction such as the one given above by supplying electricity is known as electrolysis.

### • Conventions adopted in electrolysis

- (1) The electrode connected to the positive terminal of the external electrical supply (battery) is the positive electrode whereas the electrode connected to the negative terminal is the negative electrode.
- (2) The positive ions in the solution/liquid migrate towards the negative electrode while the negative ions are attracted by the positive electrode.
- (3) The positive ions moving towards the negative electrode receive electrons and undergo reduction. If there are several positive ions in the solution, generally, the cations (positive ions) formed by the elements further down in the activity series has a higher tendency to undergo reduction.

For example, if there are  $\text{Na}^+$  and  $\text{H}^+$  ions in the solution, the  $\text{H}^+$  ions formed by hydrogen which is below sodium in the activity series receive electrons and get reduced.

If there are  $\text{Cu}^{2+}$  and  $\text{H}^+$  ions in the solution electrons are gained by the  $\text{Cu}^{2+}$  ions formed by copper which is placed below hydrogen in the activity series.

(4) Since a **reduction half reaction** occurs at the negative electrode, negative electrode is the **cathode**.

(5) The anions (negative ions) in the solution move towards the positive electrode and lose electrons. That means, they undergo oxidation.

For example, the  $\text{Cl}^-$  ions in the solution become  $\text{Cl}_2$  molecules releasing electrons.



(When there are several negative ions in the solution, which ion oxidizes first is decided by several factors. Since these facts are beyond the scope of your subject they are not discussed here).

(6) **Oxidation** occurs at the positive electrode, so positive electrode is the **anode**.

(7) If a metal (except platinum) is used as the anode, metal atoms get oxidized losing electrons instead of the oxidation of negative ions.

For example, if the anode is a silver rod, the oxidation reaction



Based on the above conventions, let us predict the reactions taking place during the following electrolysis reactions.

- **Electrolysis of fused sodium chloride using carbon electrodes**

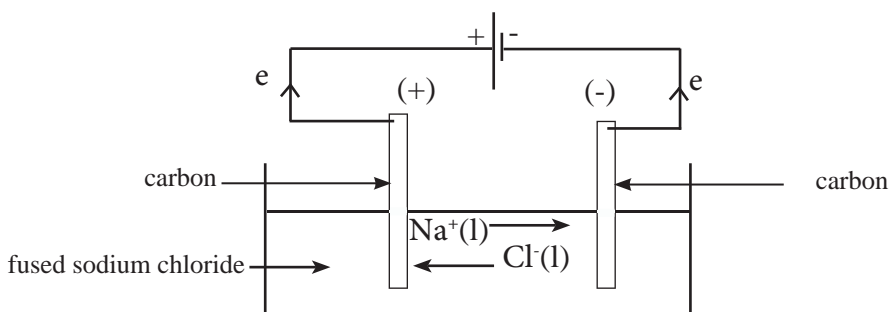

Figure 12.2.3

- **Reaction occurring at the negative electrode**

The only positive ions present in the fused (molten) liquid,  $\text{Na}^+$  ions, are attracted by the negative electrode. At this electrode  $\text{Na}^+$  ions receive electrons and become sodium atoms (Na).



Since  $\text{Na}^+$  ions are reduced by gaining electrons, this is the cathodic reaction. Accordingly, the negative electrode is the cathode.

● **Reaction occurring at the positive electrode**

Chloride ions ( $\text{Cl}^-$ ), the only negative ions present in the liquid, migrate towards the positive electrode. At this electrode,  $\text{Cl}^-$  ions get converted to chlorine molecules ( $\text{Cl}_2$ ) by removing electrons.



Since chloride ions are oxidized by losing electrons, this is the anodic reaction. Hence, positive electrode is the anode.

The overall electrolytic reaction can be obtained by adding the half reactions  $\textcircled{1}$  and  $\textcircled{2}$  appropriately.

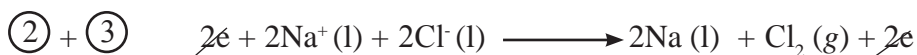
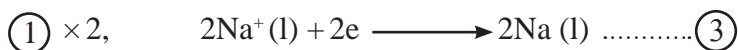

The electrolytic reaction discussed above is the reaction happening in the Downs cell to extract sodium metal industrially. This method, you will study later in more detail. Later you will study this method in more detail.

● **Electrolysis of aqueous solutions**

Now let us engage in the following activities to study the changes taking place during the electrolysis of aqueous solutions.

- Electrolysis of aqueous sodium chloride

### Activity 12.2.2

**Materials required** :- A solution of sodium chloride, carbon rods, conducting wires, a 9 V battery

**Method** :- • Connect the two carbon rods to the terminals of the battery using wires. Then immerse those two electrodes in the aqueous sodium chloride solution and observe. Record the observations.

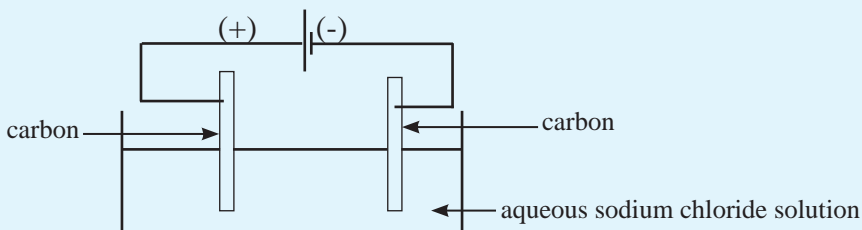

Figure 12.2.4

Liberation of gas bubbles can be observed at the electrodes. In order to explain these observations, let us understand the reactions occurring in the above experiment.

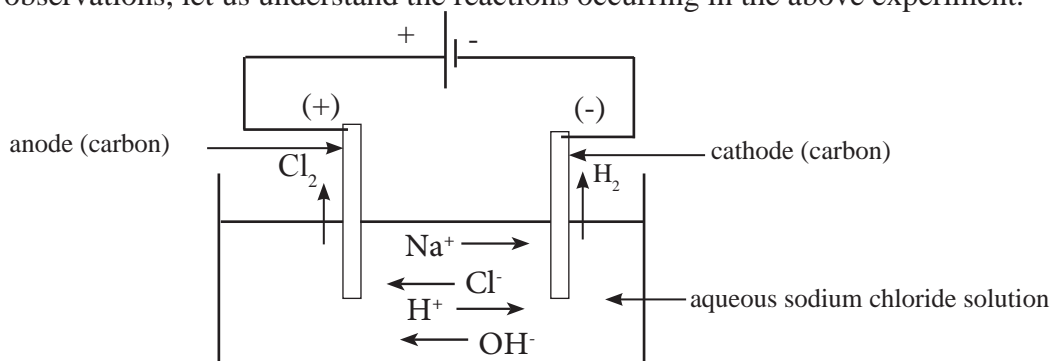

Figure 12.2.5

The solution mainly contains  $\text{Na}^+$  and  $\text{Cl}^-$  ions. In addition to these, there is a small amount of  $\text{H}^+$  and  $\text{OH}^-$  ions formed by the poor ionization of water molecules.

### For your memory file

Water is a molecule with covalent bonds. But even in pure water it has been found that a very small amount of water molecules dissociate into  $\text{H}^+$  and  $\text{OH}^-$  ions. In pure water,  $\text{H}^+$  and  $\text{OH}^-$  concentrations at  $25^\circ\text{C}$  are  $1.0 \times 10^{-7} \text{ mol dm}^{-3}$ .

● **Reaction at the negative electrode (cathodic reaction)**

$\text{Na}^+$  and  $\text{H}^+$  ions in the solution migrate towards the negative electrode.

As hydrogen is below sodium in the activity series, it is the  $\text{H}^+$  ions that are reduced here.

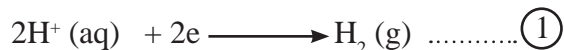

As this is a reduction occurring with the gain of electrons, the negative electrode is the cathode.

Therefore reaction  $\textcircled{1}$  is the cathodic reaction. Hence gas bubbles of hydrogen ( $\text{H}_2$ ) are evolved at the negative terminal.

● **Reaction at the positive electrode (anodic reaction)**

The positive terminal attract  $\text{Cl}^-$  and  $\text{OH}^-$  ions in the solution. Of them,  $\text{Cl}^-$  ions have a greater tendency to oxidize.



As this is an oxidation (because it involves loss of electrons) reaction  $\textcircled{2}$  is the anodic reaction.

Hence chlorine gas bubbles ( $\text{Cl}_2$ ) evolve at the positive electrode.

The overall electrolytic reaction can be obtained from the reactions  $\textcircled{1}$  and  $\textcircled{2}$

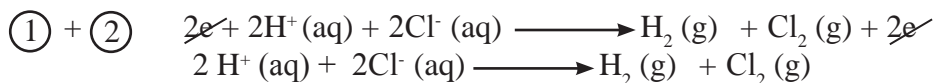

Initially the ions  $\text{Na}^+$ ,  $\text{H}^+$ ,  $\text{Cl}^-$  and  $\text{OH}^-$  were present in the solution. Of these, the ions  $\text{H}^+$  and  $\text{Cl}^-$  are removed by the conversion into  $\text{H}_2$  and  $\text{Cl}_2$  molecules. Hence  $\text{Na}^+$  and  $\text{OH}^-$  ions are left in the solution. Because of this you may understand that this reaction can be used to produce sodium hydroxide ( $\text{NaOH}$ ).

- Electrolysis of an aqueous copper sulphate solution

### Activity 12.2.3

**Materials required** :- An aqueous solution of copper sulphate, carbon rods, connecting wires, a 9V battery

**Method** :- • Connect the electrodes to the battery as follows. Then, dip the two electrodes in the copper sulphate solution and observe. Record your observations.

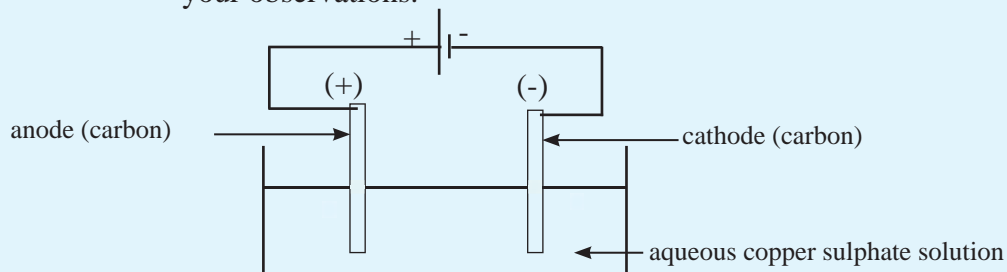

Figure 12.2.6

In this activity, it can be observed that gas bubbles evolve at the positive terminal (anode) and copper gets deposited on the negative terminal (cathode). The blue colour of the solution gradually diminishes.

In order to understand these observations, let us consider the reactions involved in here.

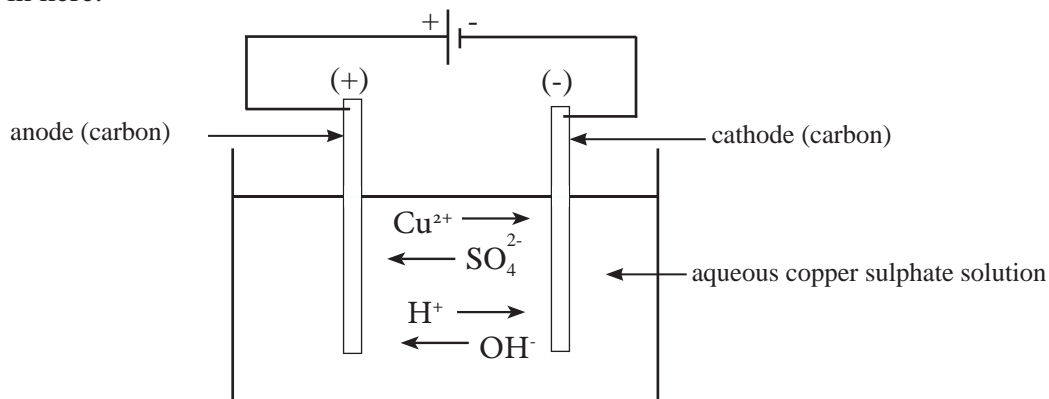

Figure 12.2.7

The solution mainly contains  $\text{Cu}^{2+}$  and  $\text{SO}_4^{2-}$  ions formed by the ionization of copper sulphate. In addition to these, a very small amount of  $\text{H}^+$  and  $\text{OH}^-$  ions formed by the slight ionization of water molecules are also present.

● **Reaction at the negative electrode**

**(cathodic reaction)**

Both  $\text{Cu}^{2+}$  and  $\text{H}^+$  ions migrate towards the negative electrode. As copper lies below hydrogen in the activity series,  $\text{Cu}^{2+}$  ions have a greater tendency to get reduced.



Hence, copper is deposited on the cathode. As this is a reduction, reaction  $\textcircled{1}$  is the cathodic reaction. Thus, negative electrode is the cathode. As  $\text{Cu}^{2+}$  ions responsible for the blue colour of the solution are removed from the solution, the intensity of the blue colour of the solution decreases.

● **Reaction at the positive electrode**

**(anodic reaction)**

$\text{SO}_4^{2-}$  and  $\text{OH}^-$  ions in the solution are attracted towards the positive electrode. Of these,  $\text{OH}^-$  ions have a greater tendency to be oxidized.

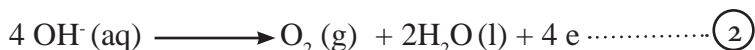

Therefore, oxygen gas bubbles evolve at the anode.

Reaction  $\textcircled{2}$  is an oxidation, so it is the anodic reaction. Hence, positive electrode is the anode.

● **For your memory file** ●

- Since the amount of  $\text{H}^+$  ions in water is negligible, sometimes the reaction  $2\text{H}_2\text{O}(\text{l}) + 2\text{e} \longrightarrow 2\text{OH}^-(\text{aq}) + \text{H}_2(\text{g})$  is considered the more fitting cathodic reaction than  $2\text{H}^+(\text{aq}) + 2\text{e} \longrightarrow \text{H}_2(\text{g})$
- Similarly the anodic reaction  $2\text{H}_2\text{O}(\text{l}) \longrightarrow \text{O}_2(\text{g}) + 4\text{H}^+(\text{aq}) + 4\text{e}$  is more appropriately used in place of  $4\text{OH}^-(\text{aq}) \longrightarrow \text{O}_2(\text{g}) + 2\text{H}_2\text{O}(\text{l}) + 4\text{e}$



- **Electrolysis of acidulated water**

Now let us pay attention to the electrolysis of acidulated water using carbon electrodes.

### Activity 12.2.4

**Materials required** :- Distilled water to which a little dilute sulphuric acid is added, carbon rods, a 9 V battery, connecting wires, a plastic cup

**Method** :-

- Pierce the bottom of the plastic cup and fix the carbon rods as shown in the figure. Seal any spaces around the rods with a substance such as molten wax or PVC so that water does not leak (silicone sealer may also be used). Add acidulated water to the cup. Introduce the two carbon rods into two inverted test tubes filled with water as shown in the figure 12.2. Supply electricity to the two carbon electrodes
- Record your observations.

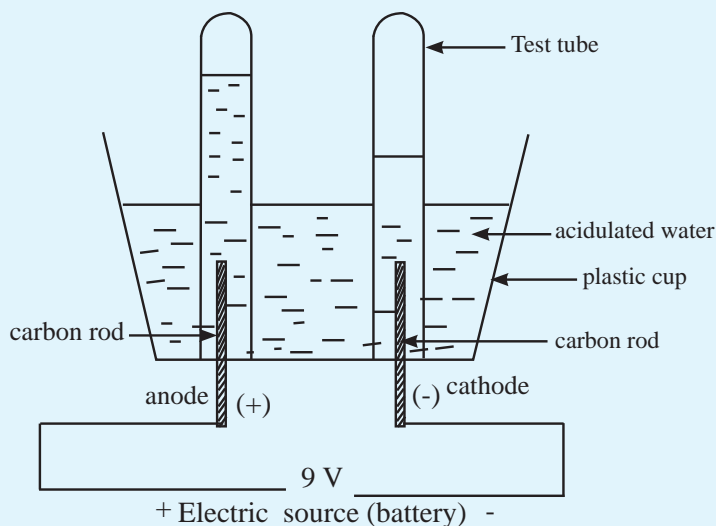

**Figure 12.2.8**

Here, we will be able to see gases collecting in the test tubes. Also, we can observe that the volume of gas liberated by the cathode is greater than that liberated by the anode. Let us investigate into the reactions taking place in this set up.

Acidulated water contains  $\text{H}^+$  and  $\text{SO}_4^{2-}$  ions provided by the ionization of dilute sulphuric acid and  $\text{H}^+$  and  $\text{OH}^-$  given by the dissociation of water.

● **Reaction at the negative electrode**

**(cathodic reaction)**

Which ions in the solution migrate towards the negative electrode? The positively charged  $H^+$  ions in the solution migrate towards the negative electrode and get reduced receiving electrons.



As this is a reduction, this is the cathodic reaction.

Hence hydrogen is liberated at the cathode.

● **Reaction at the positive electrode**

**(anodic reaction)**

The positive terminal attracts  $SO_4^{2-}$  and  $OH^-$  ions in the solution. Of these, the  $OH^-$  ions tend to undergo oxidation preferentially.

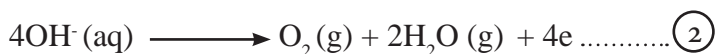

Because this is an oxidation, reaction  $\textcircled{2}$  is the anodic reaction. Thus positive electrode is the anode.

Oxygen gas bubbles are liberated at the anode.

Electrolysis of water, on the whole can be represented by the following equation.



## Industrial applications of electrolysis

Electrolysis process is frequently used in the manufacturing of various industrial products. Some examples are given below.

(1) Extraction of metals

Example :- (i) Extracting sodium metal by electrolysis fused sodium chloride

(ii) Extracting aluminium metal from bauxite

(2) Metal refining

Example :- When copper is produced from the copper ores, the copper obtained first is impure. It is purified by an electrolytic process.

(3) Electroplating (coating an object with a metal)

Example :- (i) Applying gold on silver jewellery

(ii) Applying nickel or chromium on steel

(4) Industrial production of sodium hydroxide (Diaphragm cell method)

### • Industrial production of sodium metal

We have already studied the electrode reactions occurring when fused sodium chloride is electrolyzed using carbon electrodes. The following reaction occurs at the cathode, in this process.



The reaction occurring at the anode is as follows.



The overall reaction is:

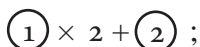

The above reaction is used to produce sodium metal industrially on large scale. For this a special type of electrolytic cell illustrated below is used. This is named the Downs cell.

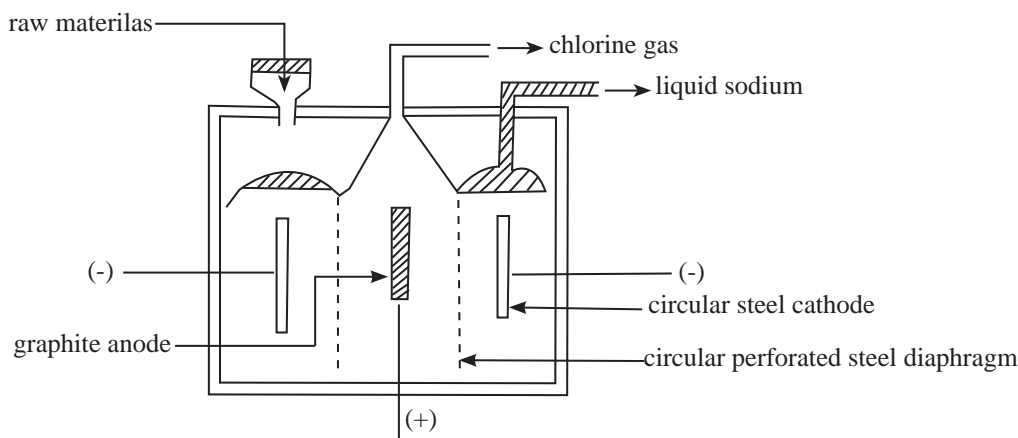

Figure 12.2.9 Downs cell

Fused sodium chloride is used as the raw material. The melting temperature of solid sodium chloride is as high as  $840^{\circ}\text{C}$ . By adding about 40% calcium chloride to sodium chloride, the melting temperature of the mixture is decreased to about  $600^{\circ}\text{C}$ .

What will happen is chlorine gas produced at the anode comes into contact with the sodium discharged at the cathode. Sodium and chlorine would react giving sodium chloride again. To prevent this, the anode and cathode are separated by a steel mesh diaphragm. It prevents the reaction between sodium and chlorine to form sodium chloride.

In this production process, chlorine gas is obtained as a by - product. Chlorine gas can also be used as a raw material for various products.

### Uses of sodium

- Used in sodium vapour lamps which emit a yellow light.
- Used as a coolant in nuclear reactors in power houses producing nuclear energy
- It is a requirement for laboratory experiments

### Uses of chlorine

- Chlorine is bubbled through water to destroy bacteria in potable water.
- Used to bleach (decolourise) paper, pulp, and cloth
- Production of hydrochloric acid by reacting with hydrogen
- Used to produce plastics such as PVC
- **Electroplating**

At the beginning of this lesson, it was stated that electroplating is used to coat jewellery with gold. In addition to that, think about the ornamental objects used to decorate houses. In many items such as vases, trays and door locks that shine with golden or silvery colour, the metallic lustre is given by a metal coating deposited on them.

Applying a thin metallic layer on a given surface using electrolysis is referred to as electroplating.

Generally the coating is a less reactive metal such as tin, copper, silver or chromium. The metal that is plated needs to have a certain special property which is absent

for the surface that is plated. Resistance for rusting, attractive colour, chemical inertness and lustrous nature are some of such properties.

When electroplating objects, it is important to know the following.

- The object to be plated should be used as the cathode.
- A solution of a salt of the metal that is used for plating should be used as the electrolyte.
- The anode should be a plate/ rod made of the metal that is plated.
- In order to have a plating of high quality, the concentration of the electrolyte should be low. Then, the rate of the reaction decreases, so the plating is effected better.

Suppose you need to coat an iron spoon with copper. What do you use as the anode and cathode of the electrolytic cell which you construct for this? What is the electrolyte you employ?

The object to be plated, that is the iron spoon has to be used as the cathode. A copper rod can be used as the anode. A solution of copper sulphate can be used as the electrolyte.

### Activity 12.2.5

**Materials required** :- An iron spoon, a copper plate, connecting wires, an aqueous solution of copper sulphate, a 9 V battery

**Method** :-

- Connect the iron spoon and the copper plate to the cell by connecting wires and immerse them at once in the copper sulphate solution.
- Record the observations.

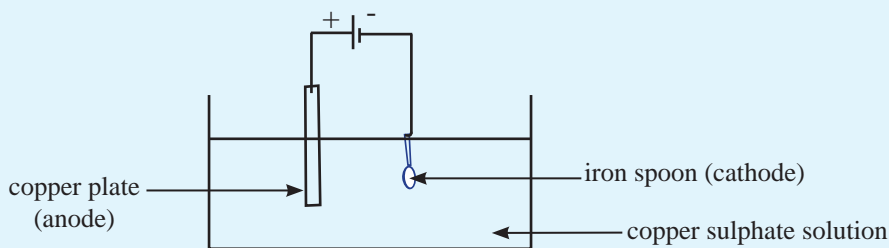

Figure 12.2.10

- **Anodic (positive electrode) reaction**

$\text{SO}_4^{2-}$  and  $\text{OH}^-$  ions in the solution migrate towards the anode. Of them  $\text{OH}^-$  ions preferentially tend to undergo oxidation. Therefore, it can be anticipated that the reaction  $4 \text{OH}^- (\text{aq}) \longrightarrow 2\text{H}_2\text{O} (\text{l}) + \text{O}_2 (\text{g}) + 4\text{e}^-$  occurs at the anode. However, it does not occur at the anode. As the anode is a metal, oxidation of metal atoms into metal ions is more feasible. Hence, the anodic reaction is



That means, the anode dissolves gradually.

- **Cathodic (negative electrode) reaction**

The solution contains  $\text{Cu}^{2+}$  ions and a little amount of  $\text{H}^+$  ions produced by the dissociation of water. Of these,  $\text{Cu}^{2+}$  ion which is less in reactivity shows a greater tendency to be reduced. Therefore, the cathodic reaction is the following.

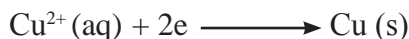

As a result, the cathode (iron spoon) gets coated with copper.

## 12.3 Corrosion of metals

Think about various metal objects that are used at home. With time, most of them are subjected to changes such as tarnishing, surface turning ditted and colour change. Subjecting metals to changes such as these when exposed to air is known as **corrosion** of metals.

Try to remind an instance where you relocated a lost item such as a knife or a mamoty blade after a long time in the garden. You would have observed that they are discoloured and decayed. Such objects are made of iron or steel. Corrosion of iron or steel exposed to air is specifically known as **rusting**.

### 12.3.1 Rusting of iron

Iron is the metal mostly used by humans. Therefore, it is the metal produced in the largest quantity. Iron manufactured is largely used to produce steel. Iron and steel are used to make vehicles, ships, bridges, machinery and many other products. Hence, rusting of iron is an economically disadvantageous process.

What kind of a process occurs when iron rusts ?

Why do the equipment made up of iron rust more easily outdoors rather than when they are indoors? Do the following activity to investigate into this

- **Finding out whether air is essential for rusting**

**Activity 12.3.1**

**Materials required** :- Two boiling tubes, ordinary cold water, coconut oil, two iron nails, burner, dilute hydrochloric acid

**Method** :-

- The iron nails available in the market has a zinc coating on them. To remove this, keep the two nails immersed in dilute hydrochloric acid for about 10 minutes and then wash with water. (Always use this procedure for experiment used the iron nail)
- Add cold water about half the height of the two boiling tubes.
- Boil the water in one of the boiling tube for about five minutes. Immerse the cleaned nails one each in the two boiling tubes. Add a little amount of coconut oil to the boiling tube with hot water to prevent the entry of atmospheric air. Allow the boiling tubes to stand for about two days and observe. Note down the observations.

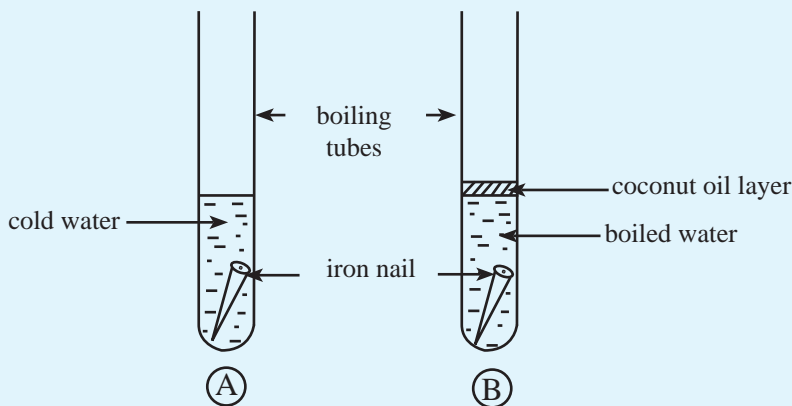

Figure 12.3.1

The nails in the above two tubes are in contact with water. But, as the water in the tube (B) is boiled, air dissolved in it has been removed. Because of the coconut oil layer, water in tube (B) does not come into contact with air, so the nail in (B) doesn't receive air. The nail in tube (A) received air (dissolved in water). All the other factors are common to the two settings.

It can be observed that the nail in tube (A) has rusted but the nail in tube (B) has not rusted. This confirms that air is essential for rusting.

Next, let us investigate which components in air are essential for rusting.

## Examining which components in air are essential for rusting

### Activity 12.3.2

**Materials required** :- Two boiling tubes, iron wool, a basin of water

**Method** :-

- In one of the boiling tubes, trap a lump of iron wool and keep it inverted in the basin of water as shown in the figure.
- Keep the other empty tube also inverted in the basin of water.
- Observe after a few days.

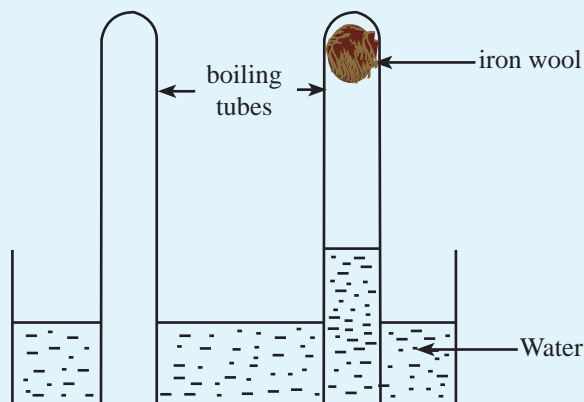

Figure 12.3.2

You can notice that the water level in the tube with iron wool has risen approximately up to  $1/5^{\text{th}}$  of the total volume of air inside the tube. Hence a part of air has been used for rusting. By composition,  $1/5^{\text{th}}$  of the volume of air is oxygen. Thus it can be concluded that it is the oxygen gas in air that is required for rusting. The gas required for rusting is oxygen.



## • Examining whether water is essential for rusting

### Activity 12.3.3

**Materials required** :- Four cleaned iron nails, two boiling tubes and two stoppers, anhydrous calcium chloride ( $\text{CaCl}_2$ ) or silica gel

**Method** :-

- Fix two cleaned iron nails to each of the rubber stopper as shown in the figure.
- Fix one of the stoppers with nails to an empty boiling tube and the other to a boiling tube with anhydrous calcium chloride or silica gel
- Observe after a few days. Record your observations.

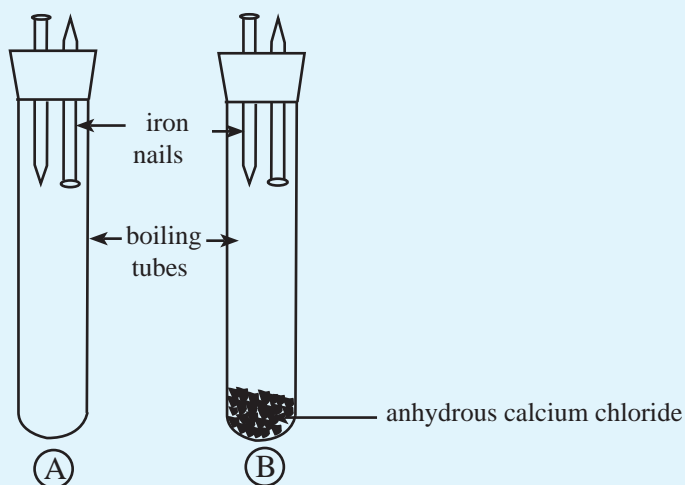

Figure 12.3.3

anhydrous calcium chloride can absorb water vapour in air.

In the above experiment, it can be observed that in the two nails in tube (A), the parts inside and outside the tube have rusted. However, in the case of (B), in the two nails, only the parts of the nails which are outside the tube have undergone rusting. As regards the tubes (A) and (B) are compared we note that tube (B) does not have water vapour in it. Other factors are common to both tubes. This shows that water is a requirement for rusting.

Next let us get on to the process taking place during rusting.

Iron atoms form positive ions by losing electrons. This means that they get oxidised. It can be represented by an equation as follows.



Metal atoms oxidise as above only when there is another species which can accept electrons.

When oxygen gas in the atmosphere and water/ water vapour are together, they get reduced accepting electrons as indicated below.

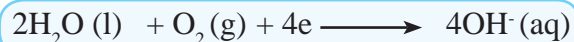

Accordingly, the half reactions occurring when iron rusts can be given as follows.

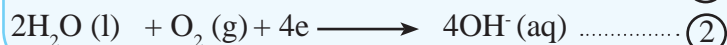
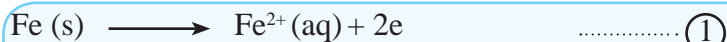

The number of electrons lost by reactions  $\textcircled{1}$  should be balanced by the number of electrons gained in reaction  $\textcircled{2}$ .

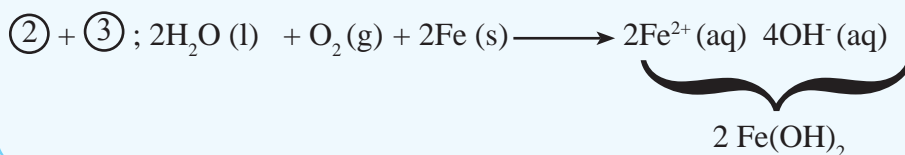

Therefore, it is clear that what occurs in rusting also is an electrochemical process similar to what you studied in the sub-unit 2.6. It can be stated that reaction  $\textcircled{1}$  is the anodic reaction (because oxidation occurs) and reaction  $\textcircled{2}$  is cathodic reaction (because reduction occurs).

$\text{Fe}(\text{OH})_2$  formed above further reacts with air to form hydrated ferric oxide ( $\text{Fe}_2\text{O}_3 \cdot \text{H}_2\text{O}$ )

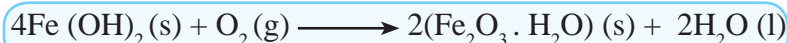

Hydrated ferric oxide is reddish brown in colour. As the number of water molecules combining with ferric oxide during hydration may vary, the formula of rust can be more appropriately given as  $\text{Fe}_2\text{O}_3 \cdot x\text{H}_2\text{O}$ .

Perhaps you would have observed that if a knife used to cut a lime was left unwashed for about a day, the part of the blade smeared with lime juice becomes rusty. Let us do the following activity to find out how acidity affects rusting.

## ● Examining how acids affect rusting

### Activity 12.3.4

**Materials required** :- Three boiling tubes, water, lime juice, dilute hydrochloric acid (HCl)

**Method** :-

- Put an iron nail each to three boiling tubes.
- Add ordinary cold water to the first boiling tube, water mixed with lime juice to the second and water mixed with dilute hydrochloric acid to the third.
- Allow to stand for about one day and observe. Record your observations.

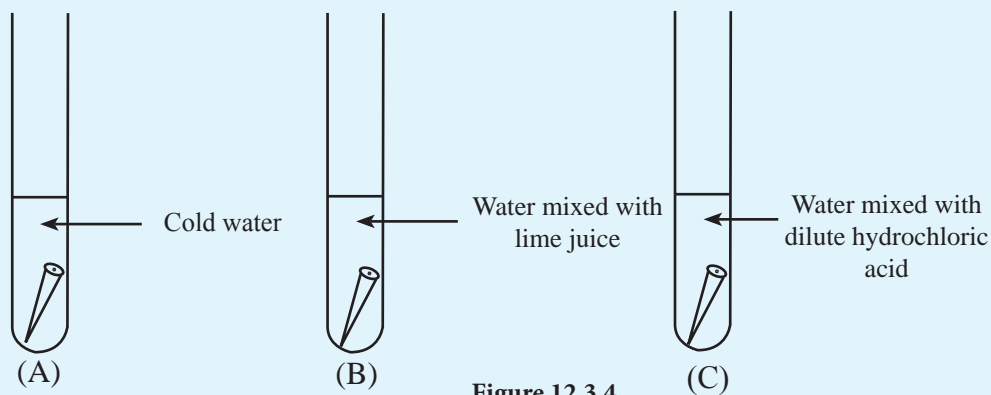

Figure 12.3.4

It can be observed that the nails in the tubes B and C have rusted more than the nail in tube A.

From this, it can be inferred that **acidity is a factor that accelerates rusting**.

Have you heard that the items made from iron used in houses in coastal areas rust faster compared to the iron objects used in other areas? In order to investigate into this, let us do the following activity.

## ● Investigating the effect of salt (sodium chloride) on rusting

### Activity 12.3.5

**Materials required** :- Cleaned iron nails, boiling tubes, solid sodium chloride

**Method** :-

- Clean two new iron nails.
- Put the two nails separately to the two boiling tubes and into one of them add water mixed with some sodium chloride and to the other tube, add ordinary cold water.
- Allow to stand for about a day and observe. Record your observations

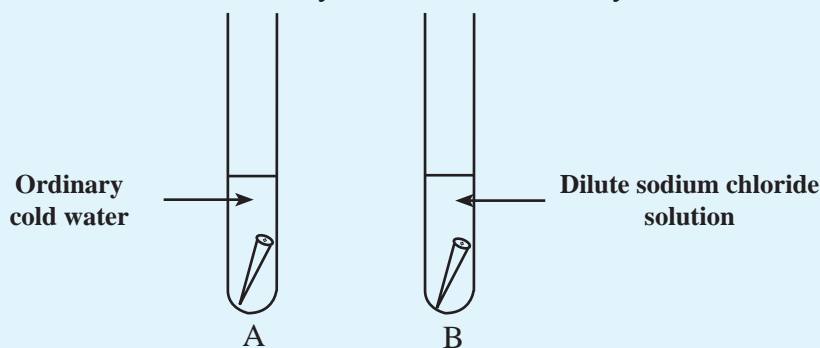

Figure 12.3.5

The nail in tube B rusts more than that in tube A. This indicates that sodium chloride has accelerated the rusting of iron. Sodium chloride is a salt. Many salts accelerate rusting. The salt concentration in coastal areas is high. Therefore, the iron objects used in those areas rust relatively faster.

We learnt that acids accelerate rusting. Next, let us do the following activity to explore how bases affect rusting.

## ● Examining how bases affect rusting

### Activity 12.3.6

**Materials required** :- Two boiling tubes, two cleaned iron nails, sodium hydroxide (NaOH) solution

**Method** :-

- Put the two cleaned nails to the two boiling tubes separately. Add equal volumes of ordinary cold water to one tube and sodium hydroxide solution to the other tube.
- Allow to stand for about a day and observe.

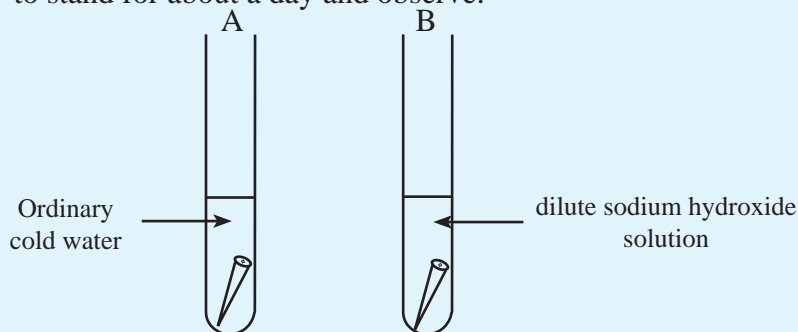

Figure 12.3.6

It can be observed that the nail in the tube with ordinary water has rusted and relative to this, the nail in sodium hydroxide solution has not rusted much. This confirms that bases decrease the speed of rusting.

The speedy corrosion of iron which is a very useful metal is a disadvantage. Therefore, steps must be taken to control the corrosion of objects made of iron.

### 12.3.2 Control of rusting of iron

What are the methods you suggest to prevent the corrosion of iron? In order to protect iron from corrosion you may propose that it is appropriate to prevent iron from coming into contact with the essential factors for rusting. In fact, if oxygen and water are kept away from iron, rusting can be prevented.

For this, following measures can be adopted.

- 1) Applying paint, grease or oil on iron  
This prevents iron from coming into contact with oxygen and water (moisture)
- 2) Coating iron with tin  
This too prevents impinging of oxygen and water (moisture) on iron.

In both instances above, the coating acts as a protective film.

Let us do the following activity to inquire into the effect of other metals on corrosion of iron.

### ● Effect of other metals on corrosion of iron

#### Activity 12.3.7

You will need :- Five cleaned iron nails, agar jelly, sodium chloride, phenolphthalein indicator, potassium ferricyanide, petri dishes, strips of magnesium, Zinc, copper and lead, water.

Method:-

- To approximately 250 cm<sup>3</sup> of water add a small amount a few of sodium chloride, phenolphthalein and potassium ferricyanide. Boil the solution and add about one tea spoonful of agar jelly to it and stir well.

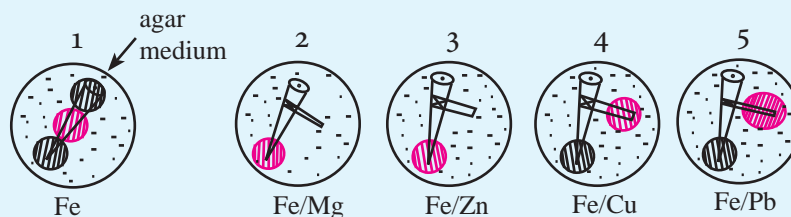
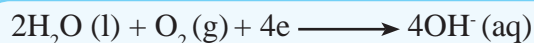

Figure 12.3.7

- Take five petri dishes. Place only an iron nail into the first petri dash. Keep the strips of magnesium, zinc, copper and lead in good contact with the other four nails. In each of the other four petri dishes, as shown in the figure. Then add the hot gel medium to all the five dishes so that the nail in each is fully covered. Allow to cool and observe after about one hour. Record the observations.

- ★ In the presence of OH<sup>-</sup> ions, phenolphthalein indicator turns pink.
- ★ Fe<sup>2+</sup> ions indicate a blue colour with potassium ferricyanide.

In the petri dishes 2 and 3 above pink colour is seen around the iron nails. That means, OH<sup>-</sup> ions are formed near the iron nail. Absence of blue colour show that Fe<sup>2+</sup> ions have not formed. In the petri dishes 2 and 3, the iron nails are in contact with magnesium and zinc which are more reactive than iron. Hence, cathodic reaction has occurred at the iron nails.



Here, the metals of higher reactivity, magnesium and zinc, act as the anode. At these metals oxidation occurs.

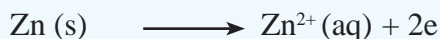

The  $\text{Mg}^{2+}$  and  $\text{Zn}^{2+}$  ions formed do not give a colour with potassium ferricyanide in the medium.

Appearance of blue colour around the iron nails in the petri dishes 4 and 5 indicates the formation of  $\text{Fe}^{2+}$  ions. This shows that the iron nails in them have corroded. In these set ups, iron acts as the anode and is subjected to oxidation as follows.

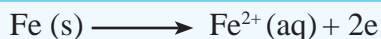

Copper and lead are placed below iron in the activity series. When iron is in contact with such a metal, iron rusts faster. Areas around copper and lead strips turning pink indicates the formation of  $\text{OH}^-$  ions closer to them. Therefore, the following reaction should have occurred at copper or lead.

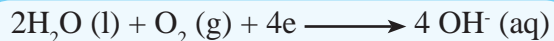

According to the above observations it would be clear to you that in order to protect iron from corrosion, a metal above iron in the activity series can be kept in contact with iron. Then, iron acts as the cathode and is protected from corrosion. Protecting iron by making it the cathode of an electrochemical cell is known as the cathodic protection or sacrificial protection.

#### **Instances where cathode protection is used:**

- Coating iron objects with zinc (galvanizing)- buckets, barbed wire, roofing sheets, GI pipes
- Welding blocks of magnesium and zinc to the hulls of the ships sailing in the sea (These blocks of magnesium and zinc should be replaced from time to time)

## Summary

- Electrochemical cells are used to convert chemical energy to electrical energy.
- A simple cell can be made by connecting two different metal rods by conducting wires and immersing them in an acid solution.
- In a simple electrochemical cell, the more reactive metal acts as the anode and the less reactive metal acts as the cathode.
- An oxidation half reaction occurs at the anode while a reduction half reaction occurs at the cathode.
- Anode is the negative terminal and cathode is the positive terminal of an electrochemical cell.
- Along the external wire, electrons flow from the anode to cathode.
- The conventional current is considered to flow from the positive terminal (cathode) to negative terminal (anode).
- Electrolysis causes chemical changes in matter by passing an electric current through a solution or a liquid.
- In electrolysis, electricity is passed through the solution or a liquid by immersing two carbon or metal electrodes in it, to which an external electrical supply is connected.
- The solution/liquid through which electricity is passed is called the electrolyte. To conduct electricity there should be mobile ions in the electrolyte.
- Since the positive terminal of the electrolytic cell acts as the anode, an oxidation half reaction occurs at the positive terminal.
- Manufacturing of useful substances from the products discharged at the electrodes is an industrial application of electrolysis.
- Industrially, sodium metal is obtained by the electrolysis of fused sodium chloride. Hydrogen and chlorine gases obtained as by-products of this are also useful chemicals.
- Subjecting the surface of a metal to chemical changes when it is exposed to atmosphere and moisture is known as the corrosion of the metal.
- Subjecting iron and steel to corrosion as above is specifically known as rusting.
- Oxygen gas and moisture are indispensable for the rusting of iron.
- Corrosion of iron is an electrochemical process.
- The anodic reaction of this process is

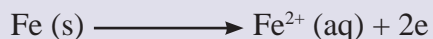



- The cathodic reaction is  

$$2 \text{H}_2\text{O} (\text{l}) + \text{O}_2 (\text{g}) + 4 \text{e} \longrightarrow 4 \text{OH}^- (\text{aq})$$
- The overall corrosion reaction can be obtained by the above anodic and cathodic reactions.  

$$2 \text{H}_2\text{O} (\text{l}) + \text{O}_2 (\text{g}) + 2 \text{Fe} (\text{s}) \longrightarrow 2 \text{Fe} (\text{OH})_2 (\text{s})$$
- By further oxidation of  $\text{Fe}(\text{OH})_2$ , hydrated ferric oxide ( $\text{Fe}_2\text{O}_3 \cdot x \text{H}_2\text{O}$ ) or rust is formed.
- Salts such as sodium chloride and acids speed up rusting.
- Bases decrease the rate of rusting.
- Rusting can be prevented by keeping iron without coming into contact with oxygen and moisture, the essential conditions for rusting.
- For this, iron can be coated with a protective layer of paint, grease or tin metal.
- When a metal more reactive than iron is in contact with iron, rusting is reduced because the reactive metal acts as the anode and iron acts as the cathode. This is called sacrificial protection or cathodic protection.
- Galvanizing iron is an example for sacrificial protection.

## Exercises

### Multiple choice questions

1. Consider a cell constructed using a zinc metal plate, an iron metal plate and dilute sulphuric acid. Which of the following statement is true about it?
  1. The conventional current of the cell flows from zinc to iron through the wire.
  2. Gas bubbles evolve at the iron electrode.
  3. Iron electrode decays.
  4. Iron electrode is the negative terminal of the cell.
2. Consider the cell constructed by immersing iron and copper electrodes in dilute sulphuric acid. Which of the following is the anodic reaction of this cell?
  1.  $\text{Cu} (\text{s}) \longrightarrow \text{Cu}^{2+} (\text{aq}) + 2 \text{e}$
  2.  $\text{Fe}^{2+} (\text{aq}) + 2 \text{e} \longrightarrow \text{Fe} (\text{s})$
  3.  $\text{Fe} (\text{s}) \longrightarrow \text{Fe}^{2+} (\text{aq}) + 2 \text{e}$
  4.  $2 \text{H}^+ (\text{aq}) + 2 \text{e} \longrightarrow \text{H}_2 (\text{g})$

3. Which of the following is an essential factor for corrosion of iron?

1. water
2. atmospheric carbon dioxide gas
3. acids
4. bases

4. Which of the following is a factor that accelerates corrosion of iron?

1. atmospheric moisture
2. atmospheric carbon dioxide gas
3. limewater
4. grease

5. In which of the following containers are the nails subjected to corrosion?

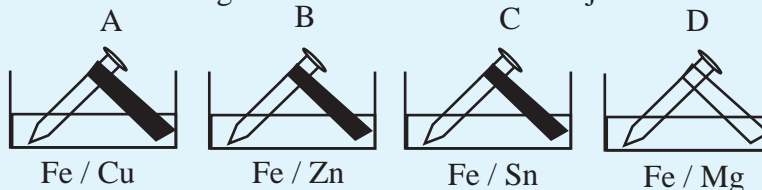

1. A and B
2. B and C
3. A and C
4. B and C

6. Which of the following statements is not true?

1. In an iron spoon the part smeared with vinegar rusts more.
2. Galvanized wire rusts when the coating is scratched.
3. A tin-coated vessel rusts when the coating is scratched.
4. Rusting of iron can be prevented by coating it with magnesium.

7. When an aqueous solution of sodium chloride is electrolysed using carbon electrodes

1. hydrogen gas is liberated at the positive terminal.
2. sodium hydroxide is formed in the solution.
3. chlorine gas is liberated at the cathode.
4. anode dissolves.

8. When a solution of copper sulphate is electrolysed using carbon electrodes

1. copper is deposited on the cathode.
2. copper is deposited on the anode.
3. oxygen gas bubbles are formed at the negative electrode.
4. the blue colour of the solution remains unchanged.

9. Which of the following is not a conductor of electricity?

1. aqueous sodium hydroxide
2. acidified water
3. solid sodium chloride
4. aqueous sodium chloride

10. During the electrolysis of acidulated water using carbon electrodes
1. hydrogen gas is evolved at the anode.
  2. oxygen gas is evolved at the cathode.
  3. hydroxide ions are generated at the anode.
  4. anode dissolves.
11. Which of the following is an occasion where electrolysis is not used industrially?
1. coating an iron spoon with nickel.
  2. extraction of aluminium metal.
  3. galvanizing iron nails.
  4. extraction of sodium from fused sodium chloride.

### Essay questions

1. Write balanced half equations for the following chemical processes. State whether the half reactions you write are oxidation or reduction.
- i. magnesium metal (Mg) turning into magnesium ions ( $\text{Mg}^{2+}$ )
  - ii. aluminium metal (Al) turning into aluminium ions ( $\text{Al}^{3+}$ )
  - iii. sodium metal (Na) turning into sodium ions ( $\text{Na}^+$ )
  - iv. hydrogen ions ( $\text{H}^+$ ) turning into hydrogen molecules ( $\text{H}_2$ )
2. Consider the following electrochemical cell constructed using zinc and lead metals.

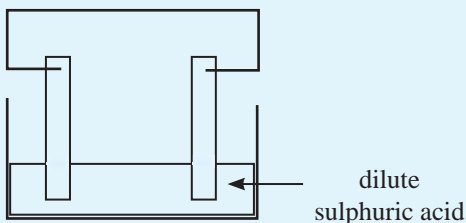

- i. Name the anode and cathode of this cell.
  - ii. Name the positive terminal and negative terminal of this cell.
  - iii. Write the anodic and cathodic reactions of this cell.
- iv. Name the electrode reactions corresponding to oxidation and reduction.
- v. Write the overall cell reaction.
- vi. Write the changes that can be observed at the electrodes.

### Technical terms

Electrolysis	- விடயனவீவீசேடனய	- மின்பகுப்பு
Electrolyte	- விடயன வீவீசேடனய	- மின்பகுபொருள்
Non-electrolyte	- விடயன அவிவீவீசேடனய	- மின்பகாப்பொருள்
Electrolytic cell	- விடயன - வீவீசேடன கைசய	- மின்பகுப்புக் கலம்
Spontaneous	- சீவயசீடீட	- சுயாதீனமான
Activity series	- சக்தியகா சூசீசய	- தாக்கவீதத் தொடர்
Bleaching	- வீரச்சனய	- வெளிற்றல்
Electroplating	- விடயன லேஹாலேசனய	- மின் ஁லோக முலாமிடல்
Anode	- அனோடிவ	- அனோட்டு
Cathode	- காதோடிவ	- கதோட்டு
Electrochemical cell	- விடயன - ரசயநிக கைசய	- மின் இரசாயன கலம்
Electrode	- ஓலேகவீவீசய	- மின்வாய்
Half reactions	- அரீட ப்ரதிக்ரீய	- அரை அயன் தாக்கம்
Flow of electrons	- ஓலேகவீவீசய டாராவ	- இலத்திரன் பாய்ச்சல்
conventional current	- சமீமன டாராவ	- நியம மின்னோட்டம்
Galvanometer	- கால்வனோமீட்டர்	- கல்வனோமானி
Oxidation	- ஓக்சீகரணய	- ஓட்சியேற்றம்
Reduction	- ரீக்சீகரணய	- தாழ்த்தல்
Negative terminal	- சாண் அகூய	- மறை முனை
Positive terminal	- டன அகூய	- நேர் முனை
Oxidation half reaction	- ஓக்சீகரண அரீட ப்ரதிக்ரீய	- ஓட்சியேற்ற அரை அயன் தாக்கம்
Reduction half reaction	- ரீக்சீகரண அரீட ப்ரதிக்ரீய	- தாழ்த்தல் அரை அயன் தாக்கம்
Anodic reaction	- அனோடி ப்ரதிக்ரீய	- அனோட்டுத் தாக்கம்
Cathodic reaction	- காதோடி ப்ரதிக்ரீய	- கதோட்டுத் தாக்கம்
Cell reaction	- கைசய ப்ரதிக்ரீய	- கலத் தாக்கம்
Corrosion	- லேஹ வீடாடனய	- ஁லோக அரிப்பு
Rusting	- ஓல ரூசீகரண	- துருப்பித்தல்
Bimetal effect	- டீவீ லேஹ அலரணய	- ஈருலோகச் சட்டம்
Sacrificial protection	- கால கிரீமீ அரணய	- தியாகப் பாதுகாப்பு முறை
Cathodic protection	- காதோடி அரணய	- கதோட்டுப் பாதுகாப்பு முறை