

**තෙවන වාර පරීක්ෂණය - 8 ශ්‍රේණිය - 2019**  
**Third Term Test - Grade 8 - 2019**

**Name :** ..... **Science** **Time :** 02 hours

**Part I**

- Answer all questions on this paper too.
- One mark for each question.
- Underline the correct choice for the question from 1 to 25.

- (01) Which is the group, organism Yeast belongs to?
1. Bacteria
  2. Protozoa
  3. Virus
  4. Fungi
- (02) The animal who use wet skin and lungs for respiration is,
1. Tortoise
  2. Gorilla
  3. Frog
  4. Earthworm
- (03) The common characteristic for the group Mollusca and group Arthropoda is,
1. Having outer shell.
  2. Having bilateral symmetry.
  3. Having wings.
  4. Having wet moisturized skin by mucos.

- (04) A balloon is tied tightly, after putting sugar and Yeast mixture into it.  
 An observation that can be obtained after few minutes is,
1. Forming a hole on a balloon.
  2. Inflating the balloon.
  3. Contracting the balloon.
  4. Not any considerable change happened.

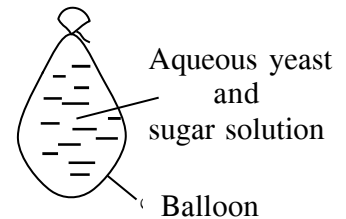

- (05) The correct choice which indicates the correct observation for putting a drop of ink on the serviette tissue paper is,
1. The drop of ink doesn't spread, due to the paper is not discontinuous.
  2. The drop of ink spreads, due to the paper is discontinuous.
  3. The drop of ink spreads, due to the paper is a solid matter.
  4. The drop of ink turns to blue, due to the paper is discontinuous.

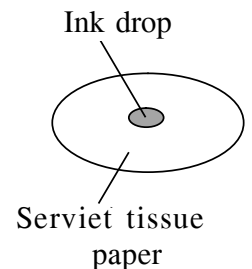

- (06) Following shows the two observable characteristics of the matter A and B.

A	Cannot be compressed/ Definite volume.
B	Can be compressed/ No definite volume.

Select the choice which shows the A and B in correct order.

1. Mercury, Water vapour
2. Sand and water
3. Mercury and water
4. Water vapour and sand

(07) A plant which adapts for storing food, propagation and dormancy is,

1. Turmeric
2. Cactus
3. Pepper
4. Radish

(08) Select the choice which contains only underground stems.

1. Onion, Leeks, Carrot
2. Banana, Ginger, Sweet potato
3. Potato, Carrot, Ginger
4. Potato, Banana, Ginger

(09) An instrument which produces sound by vibrating membranes,

1. Piano
2. Conch
3. Xylophone
4. Speaker

(10) Select the ascending order of frequency for following tuning forks.

1. A, C, B
2. C, B, A
3. B, A, C
4. B, C, A

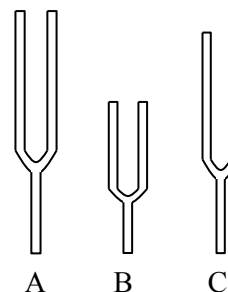

(11) An equipment which is used to find the direction of magnetic field is,

1. Multimeter
2. Galvanometer
3. Compass
4. Motor

(12) An element which uses to observe the physical property brittleness is,

1. Magnesium
2. Copper
3. Aluminum
4. Sulphur

(13) The causative agent for the disease blight of potato is,

1. a virus
2. a Fungus
3. a Bacteria
4. a Protozoa

(14) The first artificial satellite which was launched by United State of America was,

1. Sputnik - 1
2. Explorer - 1
3. Telestar - 1
4. Vostoc - 1

(15) There are three circuits which are prepared by connecting identical bulbs.

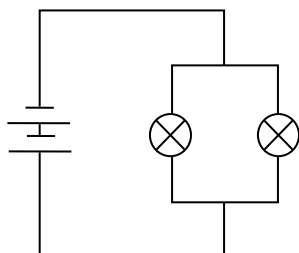

X

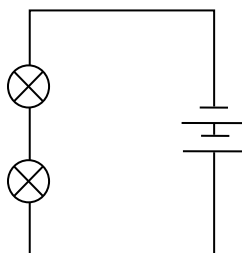

Y

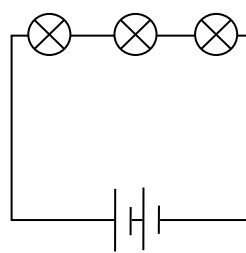

Z

Select the choice with ascending order of brightness of bulbs.

1. X, Y, Z
2. Y, X, Z
3. Z, Y, X
4. Z, X, Y

- (16) Consider the statements given below for food preservation.
- Surplus of food is wasted in food preservation.
  - The damages on food by micro-organisms and by macro-organisms are prevented by food preservation.
  - “**Spray Drying**” is a modern method used for food preservation.

The correct statements are,

- Only A and B.
  - Only A and C.
  - Only B and C.
  - All A, B and C.
- (17) When observing a geo-stationary satellite from the earth, it is observed as stationary for the earth. The reason for that is,
- The rotational speed of the geo-stationary satellite is equal to the rotational speed of the earth.
  - The rotational speed of the geo-stationary satellite is lower than the revolutional speed of the earth.
  - The rotational speed of the geo-stationary satellite is lower than the rotational speed of the earth.
  - The rotational speed of the geo-stationary satellite is higher than the rotational speed of the earth.
- (18) An advantage of adding preservatives for food is,
- Not tendency to the change the characteristic flavour.
  - Ability to increase the nutrition value of some foods.
  - Reducing the desire for natural food.
  - Ability to add non-permitted additives.

- (19) The statements are given below about Polaris.
- The Position of the Polaris does not change because it is located in line with the axis of the earth.
  - The Polaris belongs to the constellation ursa minor.
  - The Polaris can be observed in the sky of Southern hemisphere.

Correct statements from above are,

- Only A and B.
  - Only A and C.
  - Only B and C.
  - All A, B and C.
- (20) Select the correct choice with the correct connection of ammeter and voltmeter.

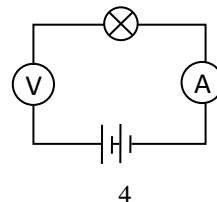
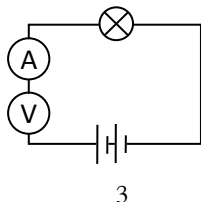
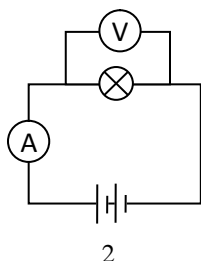
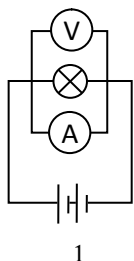

- (21) Performing better combination between stimulus and the response is called as,
- Sensitivity.
  - Stimulation.
  - Irritability.
  - Coordination.

(22) What is the natural reason for the forming of drought?

- Excessive usage of water.
- Deforestation.
- Changing the patterns of monsoon winds.
- Releasing Carbon dioxide to the atmosphere by Combustion of fuels.

(23) Consider the following statement and the reason of it.

Statement - Natural disasters are occurred by lightning and thundering.

Reason - Lightning is formed due to discharge of electrostatic charges.

Select the correct choice about above statement and reason.

	Statement	Reason
1.	False	True
2.	True	False
3.	True	True
4.	False	False

(24) What is the correct method of storing bar magnets from following choices?

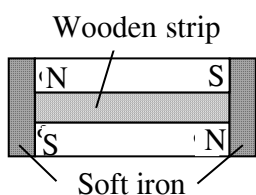

1.

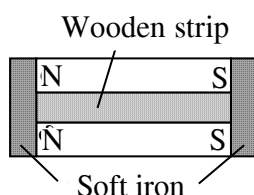

2.

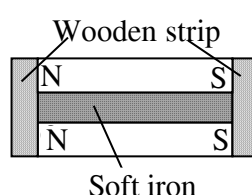

3.

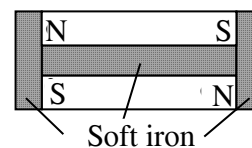

4.

(25) The causative reason/ reasons for occurring land slides is/ are,

1. Heavy rain.
2. Human activities.
3. The structure of soil which formed mountains.
4. Above all.

(25 marks)

## Part II

- Answer the 5 questions only.
- 12 marks are allocated for each.

01. Three apparatus which are prepared to show some biological processes and transport process of plants are given below.

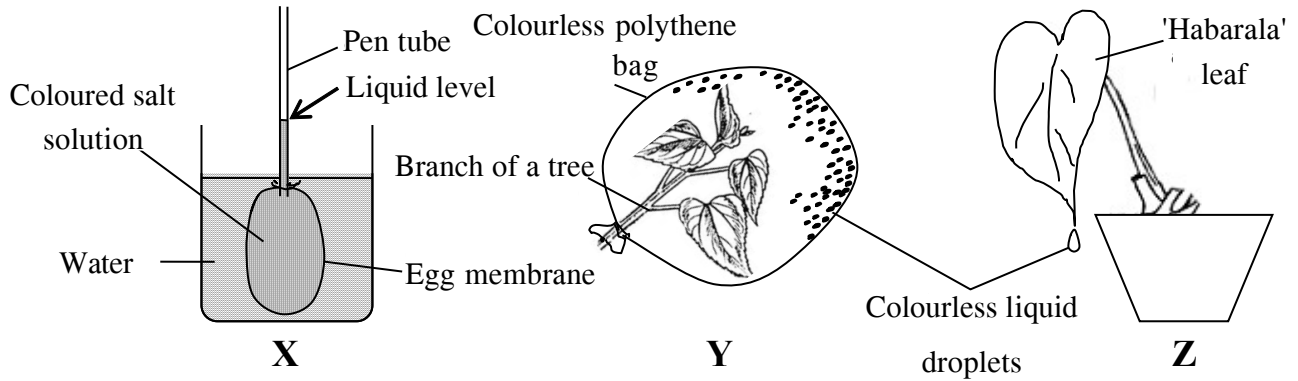

- (A) The egg membrane has well connected to the tube of a pen.
- i. After few minutes,
    - a) What could be the observation? (1 m.)
    - b) Explain the reason for the observation (2 m.)
  - ii. What is the method of transporting process which can be shown by this apparatus? (1 m.)
  - iii. Write down a benefit of colouring the salt medium. (1 m.)
- (B) A student says that the colourless droplets collected in the Y apparatus is water,
- i. To identify the droplets as water,
    - a) Name a chemical that can be used. (1 m.)
    - b) Write the colour change of it. (1 m.)
  - ii. The water droplets from the Y and Z are heated until evaporate as the figure. Then a white powder was observed at the site of one drop of water.
    - a) What could be the droplet which gives this observation? (1 m.)
    - b) Mention the reason for the observation. (1 m.)
    - c) What is the biological process which helps to release the above water droplet. (1 m.)
    - d) Simply describe the biological process involved in producing water droplets in Y apparatus. (2 m.)

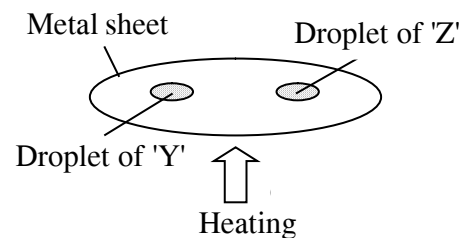

02. There are two type of metamorphosis that can be recognized by the stages of the life cycle of some animals. Following sketch is showing the relationships between them.

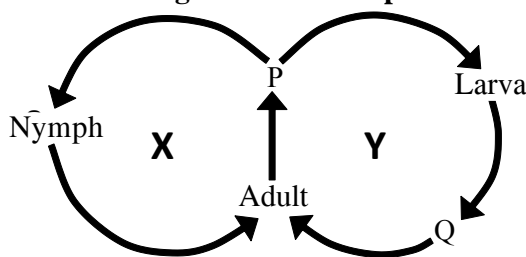

- i. Write down the suitable names for P and Q. (2 m.)
- ii. What is meant by metamorphosis? (2 m.)
- iii. Name the forms of metamorphosis in X and Y. (2 m.)
- iv. Write a name of an animal that can be taken as an example for X. (1 m.)
- v. The vector of malaria is the mosquito.
  - a) What is the form metamorphosis of mosquito from X and Y? (1 m.)
  - b) What is the pathogenic microbial group which cause malaria? (1 m.)
  - c) Name an other microbial group which cause diseases to harm except the above one. (1 m.)
- vi. To control the larval stage of mosquito,
  - a) Write a method of biological control. (1 m.)
  - b) Write a method of chemical control. (1 m.)

03. The apparatus which are prepared to introduced the physical properties of matter are shown the figures given below.

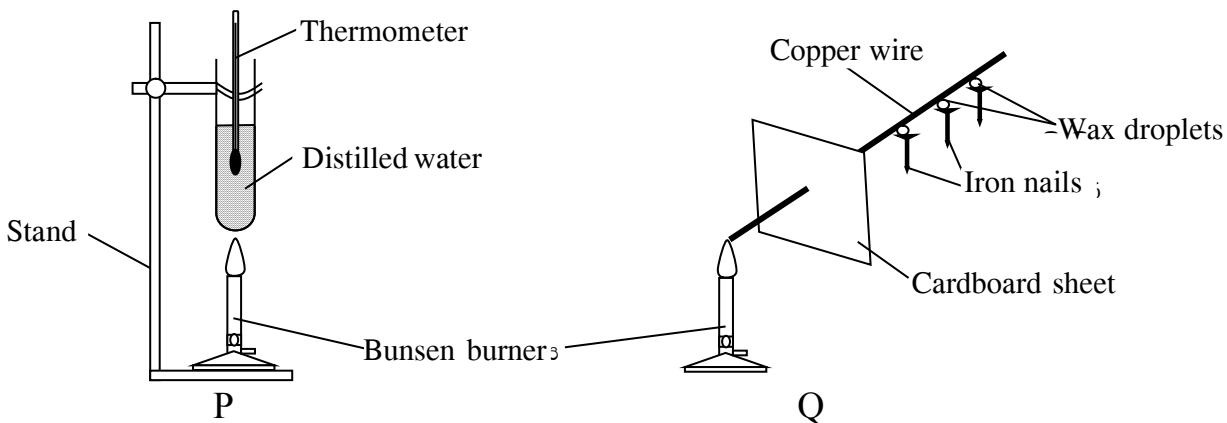

- i. Write down,
  - a) A pure liquid substance. (1 m.)
  - b) A pure solid substance used in above activities. (1 m.)
- ii. Write down the physical properties in order which can be identified by using P and Q. (2 m.)
- iii. Once, the water in the P reached the boiling point, the temperature was measured by further heating it. Then describe the pattern by which values of temperature readings may change. (2 m.)
- iv. When heating the copper wire of Q,
  - a) What could be the observation. (1 m.)
  - b) Write the reason for the observation. (2 m.)
- v. A student said that, a candle flame can be used instead of the Bunsen burner.
  - a) Write an observation that can be seen on the bottom surface of the test tube when using candle flame. (1 m.)
  - b) Write the reason for the above observation. (2 m.)

04. Below is a figure of a human urinary system.

- i. Name the parts of A, B and C. (3 m.)
- ii. What is the excretory product produced by this system(1 m.)
- iii. The organ shown as A,
  - a) Mention a disease that causes to damage it. (1 m.)
  - b) Write the reason for the above diseases. (1 m.)
  - c) Write two steps you can take to keep it healthy. (2 m.)
- iv. Except the organ shown in the figure,
  - a) Name other 2 excretory organs of human. (2 m.)
  - b) Write each of the excretory product they produce. (2 m.)

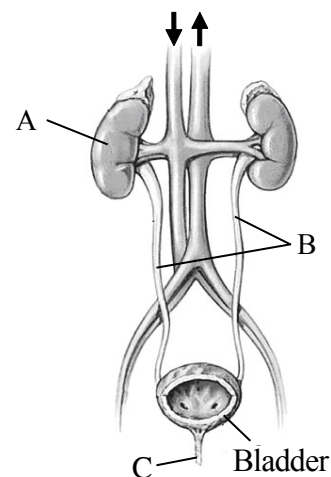

05. In the diagram is a set which can be used to identify the chemical effect of the electric current.

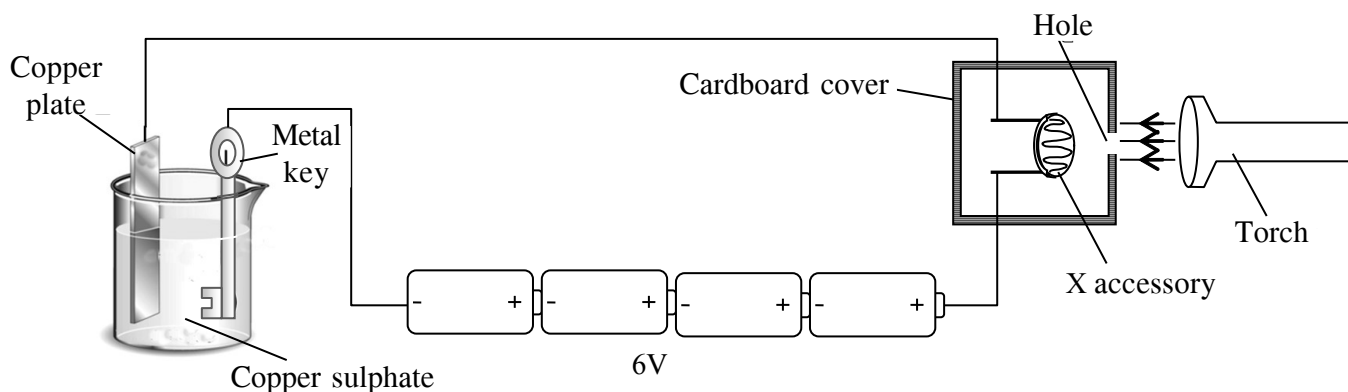

- i. Identify the x device which is connected to the circuit which helps to activate it, when switch on the torch. (1 m.)
- ii. Draw the standard symbol of X. (1 m.)
- iii. When the setup is activated,
  - a) Write an observation on the metal key (1 m.)
  - b) What is the name of the process that is being observed. (1 m.)
- iv. When the torch was turned off, the set-up is also stopped. What is the device which has the same procedure of working to the X device? (1 m.)
- v. a) What is the name of the connection of the four cells in the setup. (1 m.)
  - b) Draw it using standard symbols. (2 m.)
- vi. Write the energy conversion that takes place during the installation (2 m.)
- vii. What are the constituent elements of copper sulphate. (2 m.)

06. Below is a diagram of a student activity used to explain the behaviour of the sun, moon and earth.

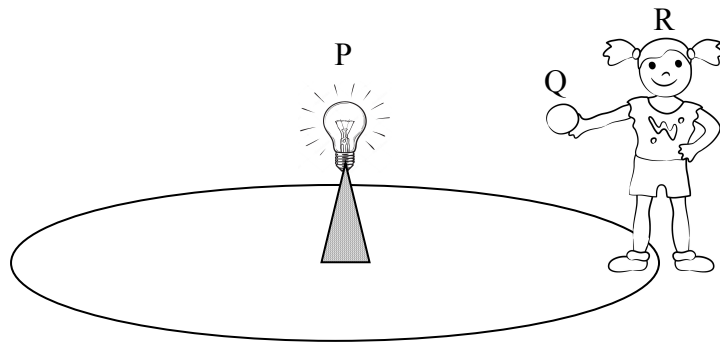

- (A) R student is standing according to the picture and rotating around the bulb while rotating around herself.
  - i. What are the English letters used to represent the sun earth and moon? (3 m.)
  - ii. **"R student is rotating around the bulb while rotating herself"**. What is the phenomenon that she followed? (1 m.)
  - iii. The positions of the P, Q and R objects in the activity are shown in two diagrams.

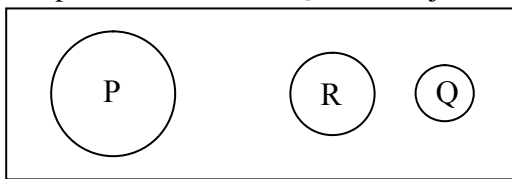

**X**

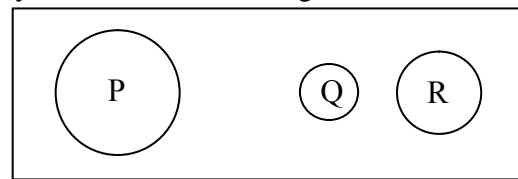

**Y**

- Based on the X and Y cases above,
  - a) What is the case that shows a solar eclipse. (1 m.)
  - b) What is the case that shows a lunar eclipse. (1 m.)
  - iv. What is the Poya day which cause a lunar eclipse? (1 m.)

(B) The images below shows two star patterns that can be observed in the night sky.

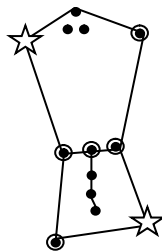

**S**

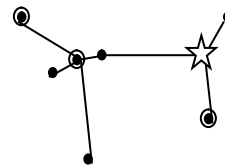

**T**

- i. Name the two star patterns. (2 m.)
- ii. What is the brightest star in the T constellation. (1 m.)
- iii. What is the unit used to measure the distance between stars? (1 m.)
- iv. Write a characteristic that can be used to distinguish a star in the night sky from a planet.

(1 m.)



**තෙවන වාර පරීක්ෂණය - 8 ශ්‍රේණිය - 2019**  
**Third Term Test - Grade 8 - 2019**

**Science - Answer Sheet**

**Part I**

- |        |        |        |        |        |
|--------|--------|--------|--------|--------|
| (01) 4 | (06) 1 | (11) 3 | (16) 3 | (21) 4 |
| (02) 3 | (07) 1 | (12) 4 | (17) 1 | (22) 3 |
| (03) 2 | (08) 4 | (13) 1 | (18) 2 | (23) 3 |
| (04) 2 | (09) 4 | (14) 2 | (19) 1 | (24) 1 |
| (05) 2 | (10) 1 | (15) 3 | (20) 2 | (25) 4 |

(25 marks)

**Part II**

01. (A)
- i. a) Rise up the salt solution level inside the tube. (01 m.)
  - b) The concentration water in the salt solution is lower than that of the outer pot. Hence water moves from pot to the salt solution through the egg membrane. (02 m.)
  - ii. Osmosis (01 m.)
  - iii. Being able to make observations clear. (01 m.)
- (B)
- i. a) Anhydrous CuSO<sub>4</sub> / Cobolt Chloride (01 m.)
  - b) White → Blue  
          Blue → Pink (01 m.)
  - ii. a) Z (01 m.)
  - b) Containing salt in the droplets. (01 m.)
  - c) Guttation (01 m.)
  - d) Water vapour releasing from aerial parts of the plant. (02 m.)

12 marks

02. i. P - egg Q - nymph (02 m.)
- ii. Having different morphological changes in different stages of life cycle. (02 m.)
- iii. X - Incomplete  
      Y - Complete (02 m.)
- iv. Cockroach (01 m.)
- v. a) Y (01 m.)
- b) Protozoa (01 m.)
- c) Virus/ Bact./ Fungi (01 m.)
- vi. a) Larval feeding fish (01 m.)
- b) Fumigation (01 m.)

12 marks

03. i. a) Distilled water (01 m.)  
 b) Fe/ Cu (01 m.)  
 ii. P - Boiling point Q - Thermal conducting (02 m.)  
 iii. Gradually increasing and at one point stop the rising. (02 m.)  
 iv. a) Gradually wax melts and pins fallen down. (01 m.)  
 b) Heat conduction along the wire. (02 m.)  
 v. a) Binding of soot/ black surface. (01 m.)  
 b) Incomplete combustion of lighted candle. (02 m.)

12 marks

04. i. A - Left kidney (No mark for kidney)  
 B - Urinary bladder/ ureter  
 C - Urethra (03 m.)  
 ii. Urine (01 m.)  
 iii. a) Suitable answer (01 m.)  
 b) Suitable reason (01 m.)  
 c) Suitable answer (02 m.)  
 iv. a) Lungs and skin (02 m.)  
 b) Lungs - exhaled air/ CO<sub>2</sub>  
 Skin - sweat (02 m.)

(02 m.)  
12 marks

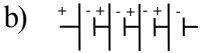
05. i. LDR (01 m.)  
 ii.  (01 m.)  
 iii. a) Redish - brown deposition in the portion of the key/ dissolving of copper plate gradually. (01 m.)  
 b) Electroplating (01 m.)  
 iv. To a switch (01 m.)  
 v. a) Series (01 m.)  
 b)  (02 m.)  
 vi. Electrical energy → Chemical energy (02 m.)  
 vii. Cu, S, O (02 m.)

12 marks

06. (A)  
 i. Sun - P Earth - R Moon - Q (03 m.)  
 ii. Revolution (01 m.)  
 iii. a) Y (01 m.)  
 b) X (01 m.)  
 iv. Full moon poya day (01 m.)

- (B)  
 i. S - Orion T - Canis major (02 m.)  
 ii. Sirius (01 m.)  
 iii. Light years (01 m.)  
 iv. A star twinkles in the sky. But planets do not twinkle. (01 m.)

12 marks



**තෙවන වාර පරීක්ෂණය - 8 ශ්‍රේණිය - 2019**

**Third Term Test - Grade 8 - 2019**

**Science**

**Practical Activity No - 01**

Materials required :-

- | Piece of wood of sized 20cm x 5 cm
- | Two iron nails
- | Piece of copper wire
- | A dry cell (1.5V)
- | A battery cover
- | A bulb
- | Switch
- | A compass

**Instructions for teachers :-**

1. Fix the two nail at the two ends of the piece of wood and tie the copper wire in it.
2. Supply necessary materials for the students and allow the students to engage in the activity.

**Criteria for marking :-**

- |  |                 |
|--|-----------------|
| 1. Arranges the circuit properly.  | (3 marks)       |
| 2. Engages in the activity properly.                                       | (3 marks)       |
| 3. Records proper observation by switching on the circuit.                 | (3 marks)       |
| 4. Records proper observations by switching off the circuit.               | (3 marks)       |
| 5. Mention the effect of electricity and placing equipment in right places | (3 marks)       |
|  | <u>15 marks</u> |

**Activity sheet for students :-**

1. Connect the bulb, switch and the dry cells in series to the two ends of the copper wire.
2. Keep the compass below the copper wire.

- Place the indicator of the compass in line with the copper wire.

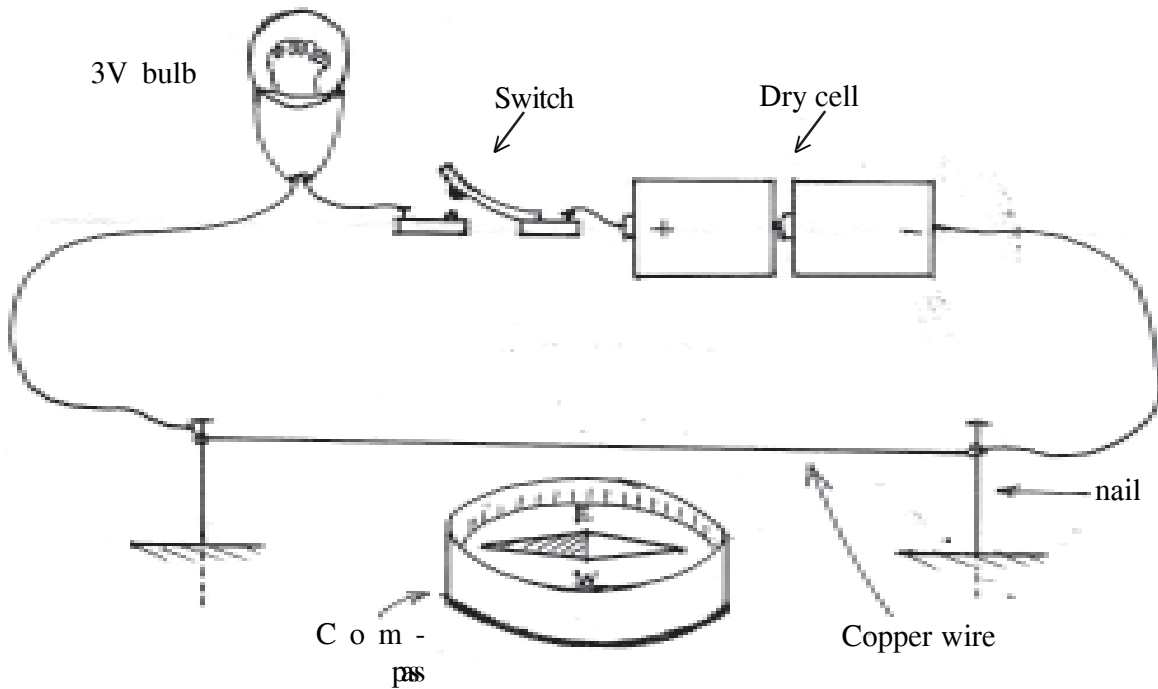

- Then switch on the circuit.
- Record your observations in the table given below.

When the switch is on	When the switch is off
01.	
02.	

- Replace the materials that you used at the proper places.
- Which effect of electricity is demonstrated in this activity.

## Practical Activity No. 02

### Materials required :-

- |                          |                              |
|--------------------------|------------------------------|
| 250ml beaker             | 6cm 5 1cm sized copper sheet |
| Two dry cells            | A cleaned iron nail          |
| Copper sulphate solution | Connecting wires             |

**Instructions for teachers :-**

1. Supply the necessary materials for the students.
2. Allow the students to work according to the instructions provided.

**Criteria for marking :-**

- |  |                 |
|--|-----------------|
| 1. Setting the apparatus properly.                 | (3 marks)       |
| 2. Performs the activity correctly.                | (3 marks)       |
| 3. Writes the observations correctly.              | (3 marks)       |
| 4. Writes correct answers for the given questions. | (3 marks)       |
| 5. Engages in the activity attentively.            | (3 marks)       |
|  | <u>15 marks</u> |

**Activity sheet for students :-**

1. Fill  $\frac{2}{3}$  of the beaker with  $\text{CuSO}_4$  solution.
2. Fix the connecting wires to the iron nail and the copper plate.
3. Connect the two dry cells seriesly.
4. Connect the copper plate and the iron nail to the positive and the negative terminals of the dry cell respectively. Then immerse them in the  $\text{CuSO}_4$  solution.
5. Observe the iron nail after 5-10 minutes.
6. Record your observations in the answer sheet.
7. Which effect of the current is demonstrated in this activity
8. Write the name of the above process taken place in the activity.
9. Write one practical application in day-to-day life where the above mentioned process is applied.
10. Replace the materials and clean your work station.

**Materials required:-**

- 1 Coconut water, Rice, Boiling tubes, Tube holders, Pipette, Benedict solution, Iodine Solution, Mortar and pestle, Bunsen burner

**Materials required:-**

A sample of soil, Two cylindrical containers of equal sized, Bunsen burner or spirit lamp, Test tube holder, Anhydrous copper sulphate, Water, Ruler, Glass rod

used and replace them at the proper places.

alone.

Activity

Heating the test tube with soil and putting anhydrous copper sulphate.

instead bar magnets.

bar magnet

15 marks

15 marks

**Activity sheet for students :-**

1. Fill 2/3 of the beaker with CuSO<sub>4</sub> solution.
2. Fix the connecting wires to the iron nail and the copper plate.
3. Connect the two dry cells seriesly.
4. Connect the copper plate and the iron nail to the positive and the negative terminals of the dry cell respectively. Then immerse them in the CuSO<sub>4</sub> solution.
5. Observe the iron nail after 5-10 minutes.
6. Record your observations in the answer sheet.
7. Which effect of the current is demonstrated in this activity
8. Write the name of the above process taken place in the activity.
9. Write one practical application in day-to-day life where the above mentioned process is applied.
10. Replace the materials and clean your work station.

- 1 Two iron naitis

**Instructions for teachers :-**

wire.

15 marks

**Criteria for marking :-**

1. Arranges the circuit properly. (3 marks)
  2. Engages in the activity properly. (3 marks)
  3. Records proper observation by switching on the circuit. (3 marks)
  4. Records proper observations by switching off the circuit. (3 marks)
  5. Mention the effect of electricity and placing equipment in right places (3 marks)
- 15 marks
6. Replace the materials that you used at the proper places.
  7. Which effect of electricity is demonstrated in this activity.
  4. Then switch on the circuit.
  5. Record your observations in the table given below.